

# eternoivica

I N N O V A T I O N L E A D E R

**SE**

**Supporto regolabile autolivellante Eterno**

IT | EN

**Eterno adjustable and self-leveling support**



PEDESTAL

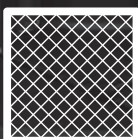

GRF



WOODECK

## Descrizione componenti

### Components description

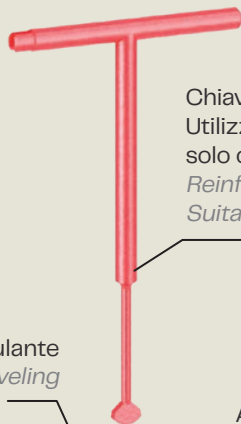

Chiave di regolazione rinforzata.  
Utilizzabile a pavimento montato,  
solo con aletta 4 mm  
*Reinforced adjustment key.  
Suitable only with standard 4 mm thick tabs*

Blocco testa basculante  
*Locking system for self leveling*

Testa autolivellante in bi-componente  
PP + gomma anti-rumore  
e anti-scivolamento  
*Two-component self-leveling head  
PP + rubber anti-noise and anti-slip*

Alette preincise per una facile  
asportazione  
*Pre-cut tabs for easy removal*

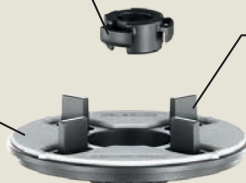

Aggancio testa-vite  
*Coupling head to screw attachment  
system*

Vite  
*Screw*



Prolunga P1  
*P1 Extension*



Sistema di blocco  
dei componenti  
*Block System*

Fori scarico acqua  
*Water drainage holes*

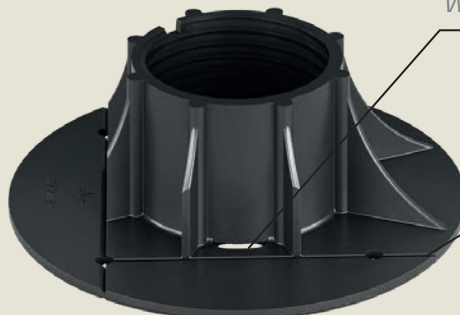

Base di appoggio  
con rottura facilitata  
*Easy-break base*



Guarda il video  
di presentazione



Watch the  
presentation video

# SE

# Supporto Eterno

## Eterno support



Un unico prodotto autolivellante o fisso, grazie all'inserimento del "blocco testa"

*A single self-leveling or fixed product, thanks to the insertion of the "head block"*



Spese di trasporto considerevolmente ridotte dato che il prodotto viene fornito assemblato

*Transport costs considerably reduced as the product is supplied assembled*

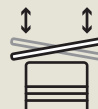

Testa autolivellante che compensa automaticamente pendenze fino al 5%

*Self-leveling head that automatically compensates up to 5% slopes*



Base con rottura facilitata per una posa più rapida

*Base with easy break for faster installation*



330 cm<sup>2</sup>

Base di appoggio liscia di 330 cm<sup>2</sup>

*Smooth support base of 330 cm<sup>2</sup>*



Blocchi di sicurezza antisvitamento

*Anti-unscrewing safety blocks*

## Teste compatibili

## Compatible heads



Testa autolivellante Ø 110 mm  
aletta 4 mm H 12 mm

*Self-leveling head Ø 110 mm  
tab 4 mm H 12 mm*



Testa autolivellante Ø 110 mm  
per travetto in alluminio

*Self-leveling head Ø 110 mm  
for aluminium joist*

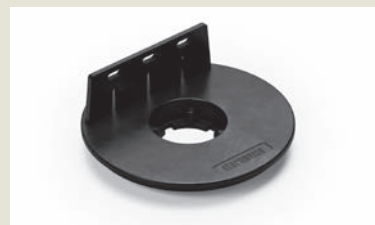

Testa autolivellante Ø 110 mm  
per travetto in legno

*Self-leveling head Ø 110 mm  
for decking*



Testa autolivellante XL Ø 150 mm  
aletta 4 mm H 12 mm

*Self-leveling XL head  
Ø 150 mm tab 4 mm H 12 mm*



Testa autolivellante Ø 130 mm  
ad incrocio per travetti in alluminio

*Self-leveling Criss-cross head Ø 130  
mm for aluminium joist*

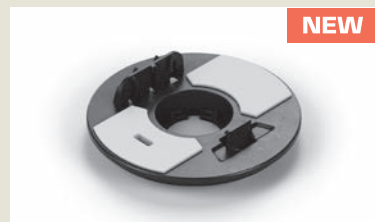

**NEW**



Testa universale fissa Ø 110 mm  
per travetti in alluminio e legno

*Universal fixed head Ø 110 mm  
for joists in aluminium and wood*

# Supporto Eterno per posa lastre direttamente sui supporti o su griglia



Eterno support for laying slabs directly on supports or on a grid

CODICE CODE	DESCRIZIONE DESCRIPTION	MISURA SIZE	PZ 	PZ 
E240028038	SE 0 con testa autolivellante Ø 110 mm, aletta 4 mm H 12 mm <i>SE 0 with self-leveling head Ø 110 mm, tab 4 mm H 12 mm</i>	28-38 mm	25	1500
E240037050	SE 1 con testa autolivellante Ø 110 mm, aletta 4 mm H 12 mm <i>SE 1 with self-leveling head Ø 110 mm, tab 4 mm H 12 mm</i>	37,5-50 mm	25	1200
E240050075	SE 2 con testa autolivellante Ø 110 mm, aletta 4 mm H 12 mm <i>SE 2 with self-leveling head Ø 110 mm, tab 4 mm H 12 mm</i>	50-75 mm	25	1200
E240075120	SE 3 con testa autolivellante Ø 110 mm, aletta 4 mm H 12 mm <i>SE 3 with self-leveling head Ø 110 mm, tab 4 mm H 12 mm</i>	75-120 mm	25	800
E240120170	SE 4 con testa autolivellante Ø 110 mm, aletta 4 mm H 12 mm <i>SE 4 with self-leveling head Ø 110 mm, tab 4 mm H 12 mm</i>	120-170 mm	25	600
E240170215	SE 5 con testa autolivellante Ø 110 mm, aletta 4 mm H 12 mm <i>SE 5 with self-leveling head Ø 110 mm, tab 4 mm H 12 mm</i>	170-215 mm	25	600
E240140230	SE 6 con testa autolivellante Ø 110 mm, aletta 4 mm H 12 mm <i>SE 6 with self-leveling head Ø 110 mm, tab 4 mm H 12 mm</i>	140-230 mm	-	-
E240185275	SE 7 con testa autolivellante Ø 110 mm, aletta 4 mm H 12 mm <i>SE 7 with self-leveling head Ø 110 mm, tab 4 mm H 12 mm</i>	185-275 mm	-	-
E240235325	SE 8 con testa autolivellante Ø 110 mm, aletta 4 mm H 12 mm <i>SE 8 with self-leveling head Ø 110 mm, tab 4 mm H 12 mm</i>	235-325 mm	-	-
E240205345	SE 9 con testa autolivellante Ø 110 mm, aletta 4 mm H 12 mm <i>SE 9 with self-leveling head Ø 110 mm, tab 4 mm H 12 mm</i>	205-345 mm	-	-
E240250385	SE 10 con testa autolivellante Ø 110 mm, aletta 4 mm H 12 mm <i>SE 10 with self-leveling head Ø 110 mm, tab 4 mm H 12 mm</i>	250-385 mm	-	-
E240300400	SE 11 con testa autolivellante Ø 110 mm, aletta 4 mm H 12 mm <i>SE 11 with self-leveling head Ø 110 mm, tab 4 mm H 12 mm</i>	300-400 mm	-	-
E240270455	SE 12 con testa autolivellante Ø 110 mm, aletta 4 mm H 12 mm <i>SE 12 with self-leveling head Ø 110 mm, tab 4 mm H 12 mm</i>	270-455 mm	-	-
E240315500	SE 13 con testa autolivellante Ø 110 mm, aletta 4 mm H 12 mm <i>SE 13 with self-leveling head Ø 110 mm, tab 4 mm H 12 mm</i>	315-500 mm	-	-
E240365550	SE 14 con testa autolivellante Ø 110 mm, aletta 4 mm H 12 mm <i>SE 14 with self-leveling head Ø 110 mm, tab 4 mm H 12 mm</i>	365-550 mm	-	-
E130125000	Prolunga P1 * <i>P1 Extension*</i>	-	25	1050

Testa alette 2-3 mm o testa liscia a richiesta.

\* Prolunga utilizzabile solo con supporti SE3, SE4 e SE5.

Tab head 2-3 mm or plane head upon request.

\* Extension element suitable only to types SE3, SE4 and SE5.

## Schema composizione SEO - SE14



### Composition table SEO - SE14



# Supporto Eterno per travetto in alluminio

Eterno support for aluminium joist



CODICE CODE	DESCRIZIONE DESCRIPTION	MISURA SIZE	PZ 	PZ 
E250028038	SE 0 con testa autolivellante Ø 110 mm per travetto in alluminio <i>SE 0 with self-leveling head Ø 110 mm for aluminium joist</i>	28 - 38 mm	25	1500
E250037050	SE 1 con testa autolivellante Ø 110 mm per travetto in alluminio <i>SE 1 with self-leveling head Ø 110 mm for aluminium joist</i>	37,5 - 50 mm	25	1200
E250050075	SE 2 con testa autolivellante Ø 110 mm per travetto in alluminio <i>SE 2 with self-leveling head Ø 110 mm for aluminium joist</i>	50 - 75 mm	25	1200
E250075120	SE 3 con testa autolivellante Ø 110 mm per travetto in alluminio <i>SE 3 with self-leveling head Ø 110 mm for aluminium joist</i>	75 - 120 mm	25	800
E250120170	SE 4 con testa autolivellante Ø 110 mm per travetto in alluminio <i>SE 4 with self-leveling head Ø 110 mm for aluminium joist</i>	120 - 170 mm	25	600
E250170215	SE 5 con testa autolivellante Ø 110 mm per travetto in alluminio <i>SE 5 with self-leveling head Ø 110 mm for aluminium joist</i>	170 - 215 mm	25	600
E250140230	SE 6 con testa autolivellante Ø 110 mm per travetto in alluminio <i>SE 6 with self-leveling head Ø 110 mm for aluminium joist</i>	140 - 230 mm	-	-
E250185275	SE 7 con testa autolivellante Ø 110 mm per travetto in alluminio <i>SE 7 with self-leveling head Ø 110 mm for aluminium joist</i>	185 - 275 mm	-	-
E250235325	SE 8 con testa autolivellante Ø 110 mm per travetto in alluminio <i>SE 8 with self-leveling head Ø 110 mm for aluminium joist</i>	235 - 325 mm	-	-
E250205345	SE 9 con testa autolivellante Ø 110 mm per travetto in alluminio <i>SE 9 with self-leveling head Ø 110 mm for aluminium joist</i>	205 - 345 mm	-	-
E250250385	SE 10 con testa autolivellante Ø 110 mm per travetto in alluminio <i>SE 10 with self-leveling head Ø 110 mm for aluminium joist</i>	250 - 385 mm	-	-
E250300400	SE 11 con testa autolivellante Ø 110 mm per travetto in alluminio <i>SE 11 with self-leveling head Ø 110 mm for aluminium joist</i>	300 - 400 mm	-	-
E250270455	SE 12 con testa autolivellante Ø 110 mm per travetto in alluminio <i>SE 12 with self-leveling head Ø 110 mm for aluminium joist</i>	270 - 455 mm	-	-
E250315500	SE 13 con testa autolivellante Ø 110 mm per travetto in alluminio <i>SE 13 with self-leveling head Ø 110 mm for aluminium joist</i>	315 - 500 mm	-	-
E250365550	SE 14 con testa autolivellante Ø 110 mm per travetto in alluminio <i>SE 14 with self-leveling head Ø 110 mm for aluminium joist</i>	365 - 550 mm	-	-
E130125000	Prolunga P1* <i>P1 Extension*</i>	-	25	1050

\* Prolunga utilizzabile solo con supporti SE3, SE4 e SE5.

\* *Extension element suitable only to types SE3, SE4 and SE5.*



**SE 8**

235-325 mm



**SE 9**

205-345 mm



**SE 10**

250-385 mm



**SE 11**

300-400 mm



**SE 12**

270-455 mm



**SE 13**

315-500 mm





**SE 14**

365-550 mm

# Supporto Eterno per travetto in legno

Eterno support for decking



CODICE CODE	DESCRIZIONE DESCRIPTION	MISURA SIZE	PZ 	PZ 
E310028038	SE 0 con testa autolivellante Ø 110 mm per travetto in legno <i>SE 0 with self-leveling head Ø 110 mm for decking</i>	28 - 38 mm	25	1500
E310037050	SE 1 con testa autolivellante Ø 110 mm per travetto in legno <i>SE 1 with self-leveling head Ø 110 mm for decking</i>	37,5 - 50 mm	25	1200
E310050075	SE 2 con testa autolivellante Ø 110 mm per travetto in legno <i>SE 2 with self-leveling head Ø 110 mm for decking</i>	50 - 75 mm	25	1200
E310075120	SE 3 con testa autolivellante Ø 110 mm per travetto in legno <i>SE 3 with self-leveling head Ø 110 mm for decking</i>	75 - 120 mm	25	800
E310120170	SE 4 con testa autolivellante Ø 110 mm per travetto in legno <i>SE 4 with self-leveling head Ø 110 mm for decking</i>	120 - 170 mm	25	600
E310170215	SE 5 con testa autolivellante Ø 110 mm per travetto in legno <i>SE 5 with self-leveling head Ø 110 mm for decking</i>	170 - 215 mm	25	600
E310140230	SE 6 con testa autolivellante Ø 110 mm per travetto in legno <i>SE 6 with self-leveling head Ø 110 mm for decking</i>	140 - 230 mm	-	-
E310185275	SE 7 con testa autolivellante Ø 110 mm per travetto in legno <i>SE 7 with self-leveling head Ø 110 mm for decking</i>	185 - 275 mm	-	-
E310235325	SE 8 con testa autolivellante Ø 110 mm per travetto in legno <i>SE 8 with self-leveling head Ø 110 mm for decking</i>	235 - 325 mm	-	-
E310205345	SE 9 con testa autolivellante Ø 110 mm per travetto in legno <i>SE 9 with self-leveling head Ø 110 mm for decking</i>	205 - 345 mm	-	-
E310250385	SE 10 con testa autolivellante Ø 110 mm per travetto in legno <i>SE 10 with self-leveling head Ø 110 mm for decking</i>	250 - 385 mm	-	-
E310300400	SE 11 con testa autolivellante Ø 110 mm per travetto in legno <i>SE 11 with self-leveling head Ø 110 mm for decking</i>	300 - 400 mm	-	-
E310270455	SE 12 con testa autolivellante Ø 110 mm per travetto in legno <i>SE 12 with self-leveling head Ø 110 mm for decking</i>	270 - 455 mm	-	-
E310315500	SE 13 con testa autolivellante Ø 110 mm per travetto in legno <i>SE 13 with self-leveling head Ø 110 mm for decking</i>	315 - 500 mm	-	-
E310365550	SE 14 con testa autolivellante Ø 110 mm per travetto in legno <i>SE 14 with self-leveling head Ø 110 mm for decking</i>	365 - 550 mm	-	-
E130125000	Prolunga P1* <i>P1 Extension*</i>	-	25	1050
Q193000203	Vite a croce per legno <i>Screw for wood</i>	Ø 3,5 mm L 20 mm	1000	-

\* Prolunga utilizzabile solo con supporti SE3, SE4 e SE5.

\* Extension element suitable only to types SE3, SE4 and SE5.



Prolunga P1  
*P1 Extension*

# Supporto Eterno (Base + Vite)

Eterno support (Base + Screw)

**TESTA ESCLUSA**

**HEAD EXCLUDED**

<b>CODICE BASE + VITE CODE BASE + SCREW</b>	<b>DESCRIZIONE DESCRIPTION</b>	<b>MISURA SIZE</b>	<b>PZ</b> 	<b>PZ</b> 
E191028038	<b>SE 0</b> base + vite <i>SE 0 base + screw</i> (B0 + V0)	28-38 mm*	25	1500
E191037050	<b>SE 1</b> base + vite <i>SE 1 base + screw</i> (B1 + V1)	37,5-50 mm*	25	1200
E191050075	<b>SE 2</b> base + vite <i>SE 2 base + screw</i> (B2 + V2)	50-75 mm*	25	1200
E191075120	<b>SE 3</b> base + vite <i>SE 3 base + screw</i> (B3 + V3)	75-120 mm*	25	800
E191120170	<b>SE 4</b> base + vite <i>SE 4 base + screw</i> (B3 + V4)	120-170 mm*	25	600
E191170215	<b>SE 5</b> base + vite <i>SE 5 base + screw</i> (B3 + V5)	170-215 mm*	25	600
E191140230	<b>SE 6</b> base + vite <i>SE 6 base + screw</i> (B3 + V3 + 1 P1)	140 - 230 mm*	-	-
E191185275	<b>SE 7</b> base + vite <i>SE 7 base + screw</i> (B3 + V4 + 1 P1)	185 - 275 mm*	-	-
E191235325	<b>SE 8</b> base + vite <i>SE 8 base + screw</i> (B3 + V5 + 1 P1)	235 - 325 mm*	-	-
E191205345	<b>SE 9</b> base + vite <i>SE 9 base + screw</i> (B3 + V3 + 2 P1)	205 - 345 mm*	-	-
E19120385	<b>SE 10</b> base + vite <i>SE 10 base + screw</i> (B3 + V4 + 2 P1)	250 - 385 mm*	-	-
E191300400	<b>SE 11</b> base + vite <i>SE 11 base + screw</i> (B3 + V5 + 2 P1)	300 - 400 mm*	-	-
E191270455	<b>SE 12</b> base + vite <i>SE 12 base + screw</i> (B3 + V3 + 3 P1)	270 - 455 mm*	-	-
E191315500	<b>SE 13</b> base + vite <i>SE 13 base + screw</i> (B3 + V4 + 3 P1)	315 - 500 mm*	-	-
E191365550	<b>SE 14</b> base + vite <i>SE 14 base + screw</i> (B3 + V5 + 3 P1)	365 - 550 mm*	-	-
E035101204	Testa bicomponente autolivellante, aletta 4 mm H 12 mm <i>Two-component self-leveling head, 4 mm tab H 12 mm</i>	Ø 110 mm	200	6400
E035100010	Testa bicomponente autolivellante per travetto alluminio <i>Two-component self-leveling head for aluminium joist</i>	Ø 110 mm	200	6400
E035102530	Testa autolivellante per travetto in legno <i>Self-leveling head for decking</i>	Ø 110 mm	100	4200
E035201204	Testa XL bicomponente autolivellante, aletta 4 mm H 12 mm <i>Two-component self-leveling XL head, 4 mm tab H 12 mm</i>	Ø 150 mm	100	3200
E035203001	Testa bicomponente autolivellante a incrocio per travetto alluminio <i>Two-component self-leveling Criss-cross head for aluminium joist</i>	Ø 130 mm	150	4800
E130125000	Prolunga P1** <i>P1 Extension**</i>	-	25	1050
E036000100	Blocco testa basculante <i>Locking system</i>	-	800***	-

Testa alette 2-3 mm o testa liscia a richiesta.

I codici dei supporti comprendono base e vite, senza testa.

\* Le misure indicate si riferiscono a Base + Vite + Testa Ø 110 mm autolivellante bicomponente.

\*\* Prolunga utilizzabile solo con supporti SE3, SE4 e SE5.

\*\*\* In sacchetti da 100 pz.

Tab head 2-3 mm or plane head upon request.

The codes for the supports include the base and screw, without the head.

\* The measurements indicated refer to Base + Screw + Self-leveling two-component head Ø 110 mm.

\*\* Extension element suitable only to types SE3, SE4 and SE5.

\*\*\* Bags of 100 pcs.



## HEADQUARTER



### ETERNO IVICA SRL

via Austria 25 / E  
Z.I. Sud - 35127 Padova - Italy

ITA +39 049 8530101

FAX +39 049 8530111

[eternoivica@eternoivica.com](mailto:eternoivica@eternoivica.com)

[www.eternoivica.com](http://www.eternoivica.com)

## FILIALI BRANCHES



 eternoivica *uk*

Londra | *London*

 eternoivica *france*

Lione | *Lyon*

 eternoivica *eastern europe*

Zagabria | *Zagreb*

MADE IN ITALY

